

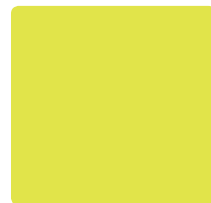























MATERIALS
HANDLING
LOGISTIC
SOLUTIONS
CATALOGUE
*Materials Handling Solutions
for the real world*



INDEX



| | | |
|--------------------------------------|---------|---|
| Nally MegaBins | 06 |    |
| Merchandising Units | 07 |    |
| Pallets | 08 |    |
| Pallet Bins | 09 |    |
| Roto Square & Rectangular Containers | 10 - 12 |    |
| Roto Drums & Buckets | 13 - 14 |    |
| Spill Guards | 15 |    |
| Tubs | 16 |    |
| Buckets (Injection) | 17 |    |
| Safety | 18 - 19 |    |

















1300 763 444

sales@spacepac.com.au

Fax: +61 2 4226 2208

SPECS

-  = Stackable
-  = Nestable
-  = Food Grade Material Used
-  = Rotationally Moulded
-  = Injection Moulded
-  = Recycled Polyethylene
-  = Low Density Polyethylene
-  = Medium Density Polyethylene
-  = High Density Polyethylene
-  = Polypropylene
-  = Unit Weight
-  = Weight Capacity (Maximum Load)
-  = Capacity (Litreage)
-  = Stock Colour

STOCK COLOUR

-  = Customer Specified
-  = Beige
-  = Grey
-  = Black
-  = Natural
-  = Red
-  = Green
-  = Orange
-  = Yellow
-  = Blue
-  = White

KEY

Please Note: Images featured in this catalogue are not to scale.

Dimensions are nominal (tolerances of up to +/- 1% should be anticipated).

For more detailed information on any of the products featured, specification sheet are available upon request.

Injection Moulded Materials: All products are manufactured from either polypropylene (temperature range of -0°C to +130°C) or high density polyethylene (temperature range -20°C to +100°C). The above temperature performance limits are dependent upon application, product design and top load requirements.

Rotationally Moulded Materials: All products manufactured by rotational moulding from high density polyethylene have a temperature range of -18°C to +65°C. The above temperature performance limits are dependent upon application, product design and top load requirements.

Note regarding Grid Mat IG051:  recommend grid matting capacity trials be carried out in each case. The load bearing capabilities of plastics improve at reduced temperatures and are lowered at elevated temperatures. Conversely, as with all plastic materials, impact resistance is reduced at lower temperatures and increases at higher temperatures.

The Nally MegaBin is the original Australian bulk bin. Designed for fruit and vegetable movement and retail high performance the Nally MegaBin is clearly the way of plastic produce bins in Australia.

Rounded corners and smoother interior surfaces results in less bruising and damage to your produce. Multiple vents in sides and base provide superior airflow so products cool faster adding valuable shelf life to your produce. Unique design with rounded entry has a larger forklift entry height than wooden bins, and the smooth, non-absorbent surface is not affected by dipping operations.

The design is compatible with most bin handling equipment. Bins feature unique moulded label holders for cards and tags. Small, exterior pads reduce scratches. Easy, clear ownership with identification with hot foil stamping. Comfortable handholds are built in for easy lifting and handling of bins. The positive interlocking foot design permits fast and safe stacking.

Nally Megabins are up to 40% lighter in weight than wood bins and the weight is constant as they don't absorb moisture. This allows for Increased freight efficiencies of 4-5%. In practice you are able to transport 2-3 extra bins of fruit per semi-trailer load.

A strong bin cover, tipping bars, liquid bungs, hotstamping and numbering are all available at your request.



MS7800 Solid MegaBin
MS7800B Solid MegaBin with Bung



MS7810 Ventilated MegaBin



MS7800T



MSLID

Above: Lid shown horizontally
Left: Lid shown vertically



Racking Feet

| Product | | | External Dimensions: | | |
|--------------|---------------------------|----------|----------------------|--------|-------|
| Code: | Product | Capacity | L | W | H |
| MS7800 | Solid MegaBin | 780L | 1165mm | 1165mm | 780mm |
| MS7800B | Solid MegaBin with Bung | 780L | 1165mm | 1165mm | 780mm |
| MS7810 | Vented MegaBin | 720L | 1165mm | 1165mm | 730mm |
| MS7800T | MegaBin with Tipping Bars | 780L | 1165mm | 1165mm | 730mm |
| MSLID | Lid to suit Bins | N/A | 1180mm | 1180mm | 35mm |
| Racking Feet | N/A | N/A | N/A | N/A | N/A |

MERCHANDISING UNITS



Don't carry it... Nally MU it. These merchandising units are Australian designed and made. They are perfect for a wide range of the genuine Nally plastic solutions and best of all they contribute to business savings.

Designed for either a pallet base or a rolling version with light weight, strong, easy flow castors the Nally MU will hold 500kg of uniformly distributed weight.

Merchandising units are not just skates, they have the ability to change the way you handle merchandise.

Designed to last, these units are made in Food Grade resin and are under 10kg to lift. There are various other features like RFID ability, movement handling, Pop Ups and attractive Sleeve Pack options. For more details talk to your Nally sales representative or customer service team today.



IH4000



IH4006

SPACEPAC
SOLUTIONS



1. IH4006 with RFC crates
2. IH4000 with stacked crates
3. IH4000 with sleeve

| Product | | External Dimensions: | | |
|---------|--|----------------------|-------|-------|
| Code: | Product | L | W | H |
| IH4000 | Nally Merchandising Unit Dolly Version | 790mm | 600mm | 195mm |
| IH4006 | Nally Merchandising Unit Pallet Version | 790mm | 600mm | 172mm |

Spacepac has a range of plastic pallets for the storage and freight of goods, which provide a host of advantages.

- Environmentally friendly
- Minimal pallet maintenance required
- Hygienic - easy cleaned & sterilized
- Economical – lightweight, reducing freight costs
- Tough and durable – great impact resistance
- Easy transport for large or small product volumes



IH537 - Vipallet



NS900 Nally Enviropal®



NS910 Nally Export Pallet



MH1672 Flat Top Pallet



MH1673 Flat Top Pallet Raised Edge

| Product | | | | | External Dimensions: | | |
|---------|---------------------|-------------------|----------------|----------------|----------------------|--------|-------|
| Code: | Product | Drive-in Racking* | Dynamic Load** | Static Storage | L | W | H |
| IH537 | Vipallet | 500kg | 1,000kg | 4,000kg | 1168mm | 1168mm | 160mm |
| NS900 | Nally Enviropal® | 1,000kg | 2,000kg | 8,000kg | 1165mm | 1165mm | 150mm |
| NS910 | Nally Export Pallet | N/A | 1,000kg | 1,000kg | 1100mm | 1100mm | 130mm |
| MH1672 | Flat Top Pallet | N/A | N/A | 500Kg | 1165mm | 1165mm | 150mm |
| MH1673 | Flat Top Pallet | N/A | N/A | 500Kg | 1165mm | 1165mm | 150mm |

*Drive-in Racking / Drive-thru Pallet Racking

**Dynamic Load - Fork-lift movement

Please Note: For all Drive - in / Drive - thru applications **Spacepac** recommend that racking trials be carried out in each case. The load bearing capabilities of plastics improve at reduced temperatures and are lowered at elevated temperatures. Conversely, as with all plastic materials, impact resistance is reduced at lower temperatures and increases at higher temperatures. All loads must be uniformly distributed on the pallet deck - no point loads.



The 1000L Pallet Bin is made from Food Grade Polyethylene and can be stacked up to two units high when full. With forklift entry storage and transport is made easy.

The 1500L Pallet Bin has a steel reinforced lip for added strength & rotatable forklift entry.

The Pallet Bin is made from Food Grade Polyethylene and can stack for transport two units high or nest.

The Poly Box has been designed to carry solid material and with forklift entry is easy to both tip and transport. The multifunctional split door also allows greater flexibility of applications and easy hand loading.



MH1630 Pallet Bin



MH1632 Pallet Bin with Tipping Bars



MH1631 Pallet Bin Lid



MH1690 Pallet Bin



MH1705 Poly Box

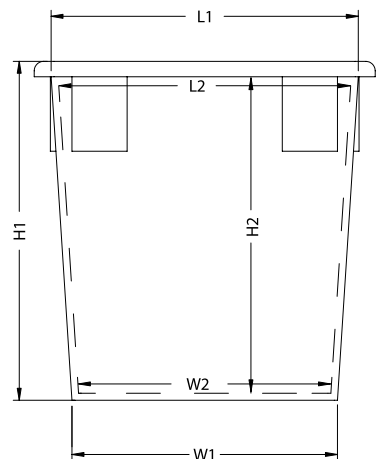

| Product | | Dimensions: | | | | | | | |
|---------|----------------|-------------|----------|--------|--------|--------|--------|-------|--------|
| Code: | Product | Volume | Capacity | L1 | W1 | H1 | L2 | W2 | H2 |
| MH1630 | Pallet Bin | 1000L | 1000Kg | 1030mm | 890mm | 1137mm | 1030mm | 890mm | 1137mm |
| MH1632 | Pallet Bin TB | 1000L | 1000Kg | 1030mm | 890mm | 1137mm | 1030mm | 890mm | 1137mm |
| MH1631 | Pallet Bin Lid | N/A | N/A | 1240mm | 1240mm | 85mm | N/A | N/A | N/A |
| MH1690 | Pallet Bin | 1500L | 1500Kg | 1157mm | 1130mm | 1395mm | 977mm | 961mm | 1395mm |
| MH1705 | Poly Box | 865L | 1400Kg | 1200mm | 1180mm | 960mm | 950mm | 935mm | 800mm |

ROTO SQUARE & rectangular containers

Versatile in both size and shape this extensive range of rectangular containers can solve your storage problems. Straight walled with robust top flanges, these containers are suitable for products ranging from food items, general materials and even chemical applications. Moulded in tough food grade polyethylene these storage tubs also have the option of a lid for extra content protection. With capacities ranging from 140L to 1380L - there is a solution to suit you.



MH1620 Rectangular Tray



MH1621 Rectangular Tray



MH1659 Rectangular Tray



TA1209 Rectangular Tank



TA1208 Square Tank*



TA1213 Rectangular Tank

*Lid also available - see p.12

| Product | Dimensions: | | | | | | | |
|---------|------------------|----------|--------|--------|---------|-------|-------|--------|
| Code: | Product | Capacity | L1 | W1 | H1 | L2 | W2 | H2 |
| MH1620 | Rectangular Tray | 50L | 800mm | 750mm | 120.6mm | 550mm | 505mm | 100mm |
| MH1621 | Rectangular Tray | 95L | 1040mm | 990mm | 116.3mm | 790mm | 740mm | 96.3mm |
| MH1659 | Rectangular Tray | 120L | 1320mm | 1200mm | 214mm | 560mm | 502mm | 190mm |
| TA1209 | Rectangular Tank | 140L | 725mm | 675mm | 530mm | 495mm | 445mm | 490mm |
| TA1208 | Square Tank | 165L | 720mm | 620mm | 510mm | 720mm | 620mm | 475mm |
| TA1213 | Rectangular Tank | 170L | 720mm | 655mm | 720mm | 490mm | 425mm | 650mm |



MH1665 Square Tank
Mobile Food Bin*



TA1216 Rectangular Tank*



TA1221 Rectangular Tank*



TA1224 Rectangular Tank*



TA1233 Rectangular Tank



TA1229 Rectangular Tank*



Image left: Mobile Food Bin & Trolley.
For more information on trolleys to accompany any of the square or rectangular containers just ask one of our friendly team today.

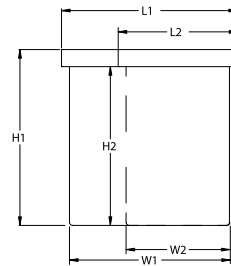

*Lid also available - see p.12

| Product | | Dimensions: | | | | | | |
|---------|-----------------------------|-------------|--------|--------|-------|-------|-------|-------|
| Code: | Product | Capacity | L1 | W1 | H1 | L2 | W2 | H2 |
| MH1665 | Square Tank Mobile Food Bin | 210L | 620mm | 570mm | 575mm | 617mm | 600mm | 545mm |
| TA1216 | Rectangular Tank | 250L | 1170mm | 1020mm | 530mm | 660mm | 510mm | 490mm |
| TA1221 | Rectangular Tank | 310L | 665mm | 560mm | 915mm | 665mm | 560mm | 880mm |
| TA1224 | Rectangular Tank | 455L | 1370mm | 1230mm | 645mm | 755mm | 615mm | 600mm |
| TA1233 | Rectangular Tank | 600L | 1175mm | 1545mm | 590mm | 885mm | 650mm | 530mm |
| TA1229 | Rectangular Tank | 690L | 1335mm | 1235mm | 975mm | 720mm | 620mm | 930mm |

ROTO SQUARE & rectangular containers **SPACEPAC** SOLUTIONS



TA1238 Rectangular Tray



TA1240 Rectangular Tray



TA1244 Rectangular Tray



TA1217 Lid to suit TA1216



TA1666 Lid to suit Mobile Food Bin MH1665



TA1210 Lid to suit TA1208 & TA1221



TA1225 Lid to suit TA1224 & TA1229

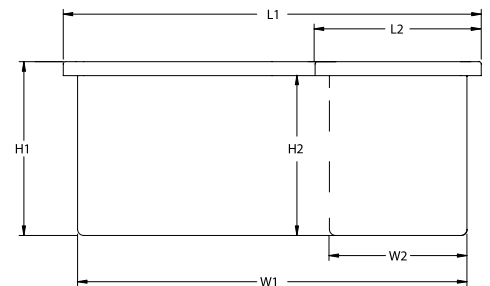

| Product | | | Dimensions: | | | | | |
|---------|----------------------|----------|-------------|--------|-------|--------|-------|-------|
| Code: | Product | Capacity | L1 | W1 | H1 | L2 | W2 | H2 |
| TA1238 | Rectangular Tank | 990L | 2045mm | 1905mm | 850mm | 815mm | 675mm | 782mm |
| TA1240 | Rectangular Tank | 1220L | 2031mm | 1905mm | 840mm | 956mm | 830mm | 785mm |
| TA1244 | Rectangular Tank | 1380L | 2140mm | 1905mm | 900mm | 1190mm | 925mm | 800mm |
| TA1217 | Rectangular Tank Lid | N/A | 1190mm | 680mm | 50mm | N/A | N/A | N/A |
| TA1666 | Mobile Food Bin Lid | N/A | 680mm | 700mm | 80mm | N/A | N/A | N/A |
| TA1210 | Square Tank Lid | N/A | 730mm | 730mm | 50mm | N/A | N/A | N/A |
| TA1225 | Rectangular Tank Lid | N/A | 1400mm | 780mm | 50mm | N/A | N/A | N/A |

ROTO DRUMS & BUCKETS



Calibrated buckets, closed head drums and tapered drums are what this range is about. The variety of sizes and assurance of clean efficient design gives the user flexibility and choice. Moulded in tough food grade polyethylene, this range of solutions is great visually and is a trusted Australian marketplace staple.



MH1600 Calibrated Bucket
& MH1601 Lid to suit



MH1605 Closed
Head Drum



MH1606 Closed
Head Drum



1300 763 444

sales@spacepac.com.au

Fax: +61 2 4226 2208



MH1607 Closed
Head Drum

| Product Code: | Product | Capacity | Dimensions: | |
|---------------|--------------------|----------|-------------|--------|
| | | | Diameter | Height |
| MH1600 | Calibrated Bucket | 25L | 315mm | 375mm |
| MH1601 | Lid to Suit MH1600 | N/A | N/A | N/A |
| MH1605 | Closed Head Drum | 125L | 495mm | 675mm |
| MH1606 | Closed Head Drum | 235L | 600mm | 865mm |
| MH1607 | Closed Head Drum | 265L | 590mm | 1040mm |

ROTO DRUMS



MH1640 Nesting Drum
MH1641 Lid



MH1643 Nesting Drum
MH1644 Lid



MH1647 Nesting Drum
MH1649 Lid



MH1648 Nesting Drum
MH1653 Lid

SPACEPAC SOLUTIONS

| Product Code: | Product | Capacity | Dimensions: | |
|---------------|-----------------------|----------|-------------|--------|
| | | | Diameter | Height |
| MH1640 | Nesting Drum | 40L | 430mm | 460mm |
| MH1643 | Nesting Drum | 58L | 490mm | 450mm |
| MH1647 | Nesting Drum with Lid | 115L | 540mm | 710mm |
| MH1648 | Nesting Drum with Lid | 215L | 630mm | 920mm |



Both the NS905 and NS906 Spillguard Bunded Pallets share the following features:

- Positive stacking for security
- Environmentally friendly, economical and easy to clean
- Corrosion and rot proof body. HDPE material for durability and chemical resistance
- One piece, no steel bar construction, cellular design
- Ideal for handling specific liquids to a wide variety of applications from aviation fuel to cooking oil
- Spill-Guard is designed for strength and is 100% recyclable
- 4 conveniently located drainage plugs for decanting

The MH1627 Bunded Pallet is designed for containing spillage of both hazardous and non-dangerous materials. With a holding capacity of 240 litres, the bunded pallet comes with a formed internal draining floor and a galvanized structural platform. A 50mm threaded drain plug is provided for easy drainage.

Grid Options include:

- Galvanized Steel grating
- Galvanized Steel expanded mesh
- Two way forklift access



NS906 Spillguard Containment Pallet - 4 Drum



NS905 Spillguard Containment Pallet - 2 Drum



MH1627 Bunded Pallet

| Product | | External Dimensions: | | |
|---------|--|----------------------|--------|-------|
| Code: | Product | L | W | H |
| NS906 | Spillguard Containment Pallet - 4 Drum | 620mm | 620mm | 280mm |
| NS905 | Spillguard Containment Pallet - 2 Drum | 1240mm | 1240mm | 280mm |
| MH1627 | Bunded Pallet | 1157mm | 1157mm | 410mm |

TUBS SPACEPAC SOLUTIONS

If its hospitality crates or tubs that you are looking for, again **Spacepac** has the answer. Designed with smooth lines, and moulded from food grade material, the hospitality range is diverse and incorporates the needs of the industry.

Whether it is your safety or the safety of your product, plastic that is manufactured by an Australian manufacturer ensures your needs are accommodated.



IH091 Meat and Poultry Tub



IH539 ViTub



IP015 Solid Tub & IP016 Lid



IP018 Solid Tub & IP016 Lid



IP025 Solid Tub & IP026 Lid

| Product | | External Dimensions: | | | |
|---------|----------------------|----------------------|----------|--------|-------|
| Code: | Product | Capacity | L | W | H |
| IH091 | Meat and Poultry Tub | 54L | 700mm | 600mm | 340mm |
| IH539 | ViTub | 200L | 990mm | 660mm | 470mm |
| | | | Diameter | Height | |
| IP015 | Solid Tub | 67L | 540mm | 508mm | |
| IP018 | Solid Tub | 84L | 540mm | 610mm | |
| IP016 | Lid to suit IP015/18 | N/A | N/A | N/A | |
| IP025 | Solid Tub | 113L | 637mm | 455mm | |
| IP026 | Lid to suit IP025 | N/A | N/A | N/A | |



N151 Solid Bucket with Handle & N148 Lid



N258 Solid Bucket with Handle & N073 Lid



N075 Solid Bucket with Handle & N073 Lid

SPACEPAC SOLUTIONS

Spacepac Industries

Enquiries: 1300 763 444 39 Ellen Street

Fax: 02 4226 2208 Wollongong, 2500

Email: Sales@spacepac.com.au NSW, Australia

Web: www.spo.net.au

| Product | | Dimensions: | | |
|---------|-----------------------|-------------|----------|--------|
| Code: | Product | Capacity | Diameter | Height |
| N151 | Solid Bucket & Handle | 13.6L | 300mm | 295mm |
| N258 | Solid Bucket & Handle | 18.2L | 360mm | 295mm |
| N075 | Solid Bucket & Handle | 22.7L | 360mm | 360mm |

In the workplace of today, safety is paramount. These solutions are about ensuring your staff are efficient and, importantly, safe as they work. **Spacepac** safety range is designed for longevity and performance with key features including:

- High tolerance to weathering, so no colour fading
- Bright colour range for high visibility
- Designed for ease of use and installation
- Easily adapted to be used in a multitude of applications



- Sturdy yet light weight construction
- Nestable for compact storage
- Temperature rated to 30°C
- Optional rubber feet
- Four way access
- Anti-slip pads
- High visibility



1t* - See note regarding Grid Mat on p.5



IN3020 - Secure Step

Spacepac Secure Step has been designed to allow the user to reach higher places safely. With four way access the Secure Step offers a safe brightly coloured, work platform with large contrasting anti-slip pads on all contact surfaces. Nestable for easy storage, lightweight and with optional rubber feet, the **Spacepac** Secure Step is a step ahead of the rest.

IG051 - Grid Mat

| Product | | Dimensions: | | | |
|---------|-------------|---------------|---------------|-------------------|--------------|
| Code: | Product | Base Width | Platform Area | First Step Height | Total Height |
| IN3020 | Secure Step | 490mm x 490mm | 400mm x 400mm | 180mm | 360mm |
| | | L | W | H | |
| IG051 | Grid Mat | 508mm | 508mm | 25mm | |



- Easy installation
- Easy maintenance
- No colour loss due to weathering
- Reduces damage to racking
- Excellent impact strength
- Quick release fasteners
- High visibility



IN3015 - Racking Protector

This product has been designed to reduce damage to your racking and equipment. Ideal for delivery zones or areas with high forklift movement, the innovative design combines excellent impact strength without compromising your storage space and can be moulded in a range of colours to suit your workplace.



- Easy installation
- Easy maintenance
- No colour loss due to weathering
- Reduces damage to corners or racking
- Excellent impact strength
- Fastening points
- Optional Velcro
- High visibility



IN3010 Corner Protector

The Corner Protector has been designed to reduce damage to your walls or racking. Ideal for both delivery zones or areas with high forklift movement, the innovative design combines excellent impact strength without compromising your storage space. The Corner Protector can also be moulded in a range of colours to suit your workplace.

- Modular system to suit any carriage ways
- Highly effective in controlling traffic speed
- Coloured for high visibility
- End caps available

Note: Both Speed Hump (IN39750) & End Cap (IN3976) shown in image to right.



IN3975 Speed Hump IN3976 End Cap

This cost effective alternative to concrete/steel speed humps is ideal for all high traffic areas. Constructed from UV stabilised LLDPE, its resistance to weathering and structural integrity provide excellent long-term load bearing capabilities, while the modular design makes installation easy. High tolerance to wear & weathering



Note: Two units (IN3005) shown in image to left.

- Reduces structural damage as well as damage to equipment
- Suitable for use with 200, 250 & 310 Universal Columns
- Low profile reduces loss of space
- High tolerance to weathering
- Easily installed and maintained
- High visibility



IN3005 - Column Protector

This innovative product is designed to reduce structural damage by reducing potential impact on 'I' beams as well as to protect your valuable equipment. The Column Protector is ideal for structures with high delivery or forklift movement, whilst the low profile construction provides optimal impact strength without reducing your available workspace.

SPACEPAC

SOLUTIONS



- Protects your downpipe from costly damage repairs
- High tolerance to weathering
- Light weight
- High visibility
- Six Fastening points



IN3000 - Downpipe Protector

This product is designed to prevent costly damage to downpipes and cars, whilst its flexible design suits both rectangular and circular downpipes. The adaptable low profile construction also provides optimal impact strength without intruding on available car parking space. Designed to protect your car as well as your downpipes



IN4610 - Fender Guard



- Saves you money by avoiding costly repair jobs
- Ability to be used in a multitude of applications
- Prevents structural damage
- Bright in colour
- Easily installed

Flexibility of design allows this innovative new product to be used for a variety of applications. The Fender Guard is made from UV stabilised LLDPE and cushions the impact of any number of objects including boats, cars and forklifts. This product is ideal for marinas, car parks and factories.



| Product | | External Dimensions: | | |
|---------|--------------------|----------------------|-------|--------|
| Code: | Product | L | W | H |
| IN3015 | Racking Protector | 131mm | 184mm | 500mm |
| IN3010 | Corner Protector | 165mm | 65mm | 1200mm |
| IN3975 | Speed Hump | 800mm | 412mm | 63mm |
| IN3005 | Column Protector | 150mm | 120mm | 1200mm |
| IN3000 | Downpipe Protector | R166mm | 333mm | 1000mm |
| IN4610 | Fender Guard | 150mm | 50mm | 1250mm |