

Replaces all previous versions

Effective 1st October 2007

SPEEDFRAME Innovative Modular Framing Systems

Architects, designers and developers Australia-wide are using the diverse capabilities of our unique framing system to bring new initiatives into the marketplace for your benefit.

APPLICATIONS



COMMERCIAL

Large scale projects encompassing entire refurbishments or new developments.



DOMESTIC

Apartment kitchens, upmarket domestic kitchens and a range of versatile products

- AVAILABLE IN STEEL OR ALUMINIUM
- DIY FLAT PACKS
- NO PAINTING OR WELDING REQUIRED
- CUT TO LENGTH SERVICE AVAILABLE
- WE CAN DESIGN & INSTALL



INDUSTRIES

Storage, shelving, worktables, benches and smart display units.



LIFESTYLE / OFFICE

Workstations, partitioning systems and office storage solutions.



RETAIL

Complete shop fitouts, gondola stands, showcases, display units and point of sale units

FEATURES

- READY TO USE** : All speedframe components are pre-finished - no welding, no special treating and no waiting for paint to dry.
- EASY TO ASSEMBLE** : No Special skills are needed and only simple tools. Strong joints are guaranteed.
 Accessories are designed for easy assembly.
- CUT TO SIZE** : Local Speedframe Centres can supply tube cut to length - making each project even easier.
- STRONG, RIGID CONSTRUCTION** : One piece metal joints with plastic inserts give strong rigid frameworks.
- EASY TO DESIGN** : No special knowledge or technical drawings are required. A simple sketch is all you need.
- VERSATILE** : Choose any size, height or length. Speedframe takes care of requirements not covered by standard systems.
- RE-USABLE, RE-LOCATABLE** : Widely used for exhibitions and mobile displays.
 Speedframe is ideal for on-site assembly or pre-fabricated components.
- ACCESSORIES** : All you need for panelling, glazing, cladding and shelving.



Pre-finished tube and accessories. End caps assure a neat finish.

Simple tools for easy assembly.

Choice of castors for smooth movement. Screw-in feet for easy levelling.

Strong rigid reliable joints - Square or rounded to suit your design.

Simple format for easy design. Soft insert option for re-makeable joints.

Supports for drop shelves.

Hook-in shelf supports and cantilever arms for adjustable and display shelving.

All prices/specifications subject to change without notice.

Replaces all previous versions

Effective 1st October 2007

SPEEDFRAME Innovative Modular Framing Systems

4 EASY STEPS TO MAKING YOUR OWN SPEEDFRAME® STRUCTURE

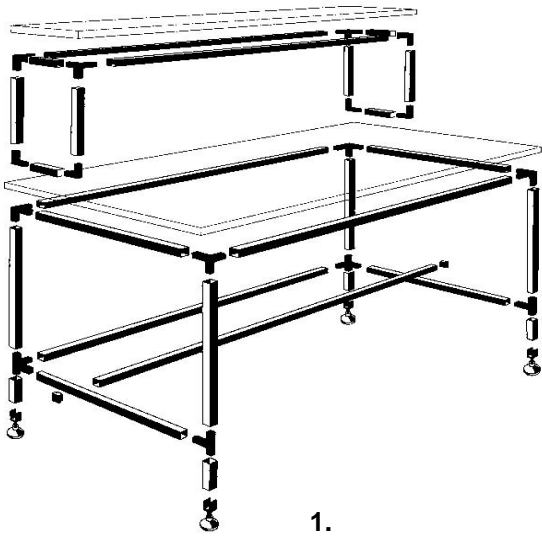

1. Once you have worked out what you are going to construct, simply order the number of tubes you will need together with the joints and inserts, plus any accessories.
 You need to allow 27mm for each joint and insert when calculating the length of the tube you need. You may find it helpful to produce a rough sketch with a list of items you need to order.
2. Cut the tube to the size you need. Alternatively you can order tube pre-cut to size.
3. Push an insert into the end of the tube and then a joint into the insert.
4. Hammer the joint home to create a solid structure.



2.



3.



4.

ASSEMBLY

SPECIAL POINTS FOR ALLOY SPEEDFRAME

1. Mitre fins of the section, if necessary, using nylon template and clippers or fine toothed hacksaw.
2. Cladding must be fitted before framework is completed.
3. Glass can be inserted after framework is completed as it is retained by snap-in bead.
4. In situations where the pinning punch cannot be used owing to the fins, drill a 5mm hole, 17.5mm from the end of the tube.

1. JOINTS

Standard Speedframe joints provide the seven possible right-angle intersections of square tube. The joints are pressure die-cast in aluminium alloy and stoveenamelled to simulate the finish of the tubes. Joints type 6.6 are supplied unfinished as they are not visible when assembled.

2. APPLICATIONS

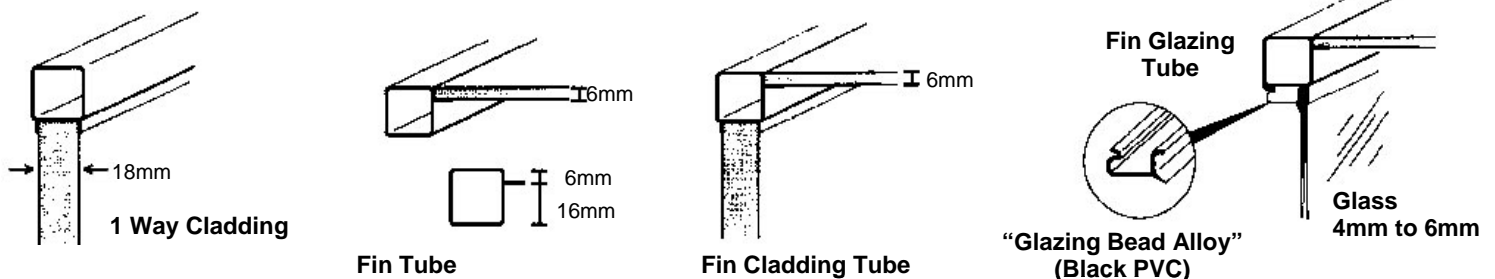

3. PANELINK

A simple system for connecting panels (made from alloy tube) together at any angle to provide self-standing displays. The Panel Link Set consists of 4 silver type 1.1 joints, 2 top screws, 2 levelling screws and nuts, 2 link plates and 4 screw caps. (see Figure 5).

**Non Standard Item
 POA**

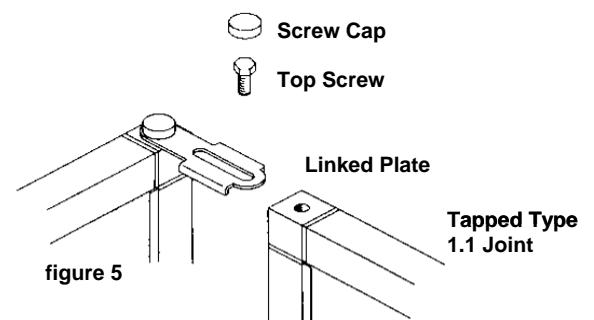

All prices/specifications subject to change without notice.

Replaces all previous versions

Effective 1st October 2007

SPEEDFRAME Innovative Modular Framing Systems

DESIGNING

1. Sketching the unit

Make a simple sketch of the unit to be built. Show tube lengths and joint numbers. (figure 1)
 (To calculate overall dimensions add 1.6mm to tube length for each insert and 25.4mm for each joint).
 Beside the sketch make a list of materials needed-tube lengths, joints, inserts, shelf supports, shelving material etc.. referring to the Speedframe Components Guide.

List of materials

(Dimensions shown refer to tube lengths)

Square Tube Joints Joints

- 4 off 800mm = 3200mm off 4.1 (1pkt)
- 4 off 500mm = 2000mm off 5.2 (1pkt)
- 4 off 450mm = 1800mm
- 4 off 150mm = 600mm Accessories
- 28 off inserts
- Total = 7600mm 4 off Adjustable feet

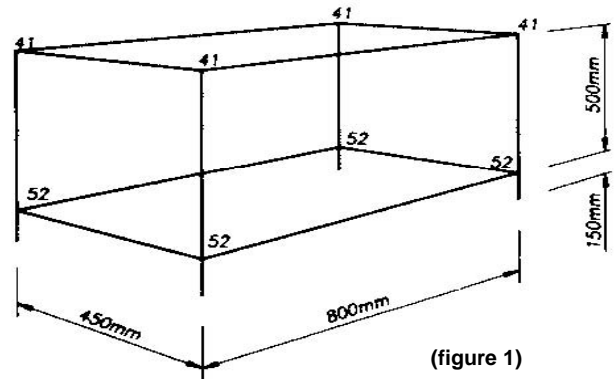

(figure 1)

2. Design Rules

- (i) Load bearing capacity depends on design of structure: for instance, a cube of Speedframe is much stronger than a structure with long legs. Avoid continuous spans of more than 1829mm. The following table can be used as a guide to safe beam loadings.

Alloy Speedframe

Alloy system takes approximately 1/3 steel beam loads.

- (ii) Intercepted members must never be load-bearing unless they are supported by a downward strut (Figure 3). When calculating lengths of intercepted members allow for size of joint and inserts (Figure 4).
- (iii) When designing with slotted tube always work in 25.4mm modules. When cutting slotted tube always cut midway between slots.
- (iv) To strengthen legs of structures always fit base not more than 152mm above the ground. When building trolleys either fit base ties at the bottom and use plate-fitting castors or fit reinforced leg units and use 102mm diameter plug-fitting castors. When fitted in this way these castors are suitable for industrial use and will carry loads of up to 68 kg per castor.

Steel Speedframe

Safe distributed load per beam

Span	Load
610mm	200kg
914mm	100kg
1219mm	65kg
1524mm	40kg
1829mm	30kg

Fig. 2

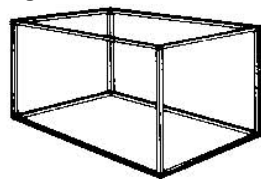

A cube of Speedframe is very strong



Wrong

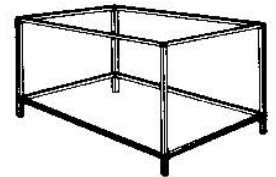

This is correct provided legs are not more than 152mm long

Fig. 3

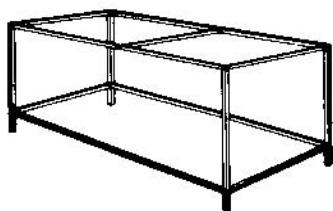

Wrong

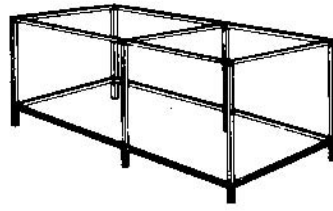

Correct. All joints supported by downward struts

Fig. 4

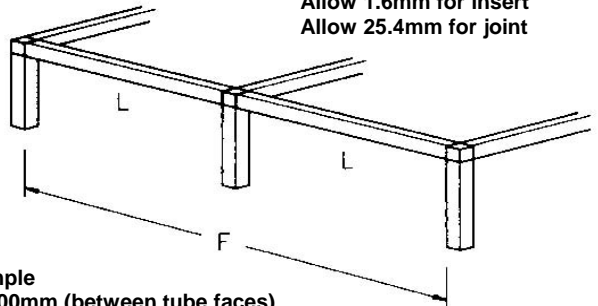

Example
 F = 800mm (between tube faces)
 Then L = 384mm (tube length)

All prices/specifications subject to change without notice.

Replaces all previous versions

Effective 1st October 2007

SPEEDFRAME Innovative Modular Framing Systems

DESIGNING

3. CUTTING

If not using ready-cut lengths, cut tube to size using a hacksaw and a Speedframe trimming block. (the block should be screwed down to a firm working surface.)

For maximum economy, cut longest lengths first. Carefully remove burrs from cut ends of the tube using a file.

4. MAKING JOINTS

Push insert into open end of tube. Use hard inserts for rigid structures, soft white inserts for structures to be frequently dismantled and rebuilt. Select the joint required and push the arm of the joint into end of tube. (If using single or double shelf supports these should be sandwiched between joint and insert at this stage). Strike the head of the joint (not the arms) with the white face of the Speedframe hammer to drive the joint home, the insert will then retain it firmly in place. Avoid hammering open ends of tube - interpose a piece of wood. Speedframe frame-works can be dismantled by knocking apart with the Speedframe hammer.

Speedframe joints likely to suffer severe vibration or pull-out loads should be permanently fixed by pinning as follows: Before making the joint punch a hole through the tube with the pinning punch to align with the hole provided in the arm of the joint. Tap in the joint with the Speedframe hammer then use an ordinary hammer to fit a drive screw into the hole in the tube so that it passes into the hole in the joint arm.















Note: Some joint arms have no holes. To pin these drill a 4.7mm diameter hole through them to accept the drive screw.

IMPORTANT

Failure to properly apply the design and assembly instructions contained herein may result in you building an unsafe structure. If in any doubt whatsoever, contact your local Speedframe centre for advice before proceeding.

5. TUBE PROFILES

The Alloy Speedframe system comprises a range of extruded aluminium tubes, with joints and inserts as for the steel system. These extrusions cater for a wide range of cladding and glazing requirements and allow considerable flexibility in designing display partitioning and exhibition applications. The natural anodised finish, with colour/matched joints, is durable and aesthetically pleasing.

- | | | | | |
|--|--|--|--|---|
| 1  Plain tube
25 mm square
070821 | 2  1-way
cladding tube
070822 | 3  2-way cladding
tube (opposite)
070823 | 4  2-way cladding
tube (adjacent)
070824 | 5  3-way
cladding tube
070825 |
| 6  Fin tube
070826 | 7  Fin-cladding
tube
070827 | 8  Fin-glazing
tube
070828 | 9  1-way
glazing tube
070829 | 10  2-way glazing
tube (opposite)
070830 |
| 11  2-way glazing
tube (adjacent)
070831 | 12  Glazing-cladding
tube (opposite)
070832 | 13  Glazing-cladding
tube (adjacent)
070833 | 14  Glazing bead-
for Alloy Tube
070834 | 15  Double fin
(opposite)
070835 |



All prices/specifications subject to change without notice.

Replaces all previous versions

Effective 1st October 2007

SPEEDFRAME Innovative Modular Framing Systems

COMPONENTS

= JOINTS



JOINT 1.1

Code	Colours
# 070211	Natural
# 070201	Black
# 070901	Silver

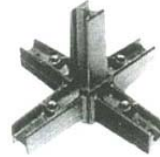

JOINT 6.3

Code	Colours
# 070216	Natural
# 070206	Black
# 070906	Silver



JOINT 2.2

Code	Colours
# 070212	Natural
# 070202	Black
# 070902	Silver



JOINT 6.6

Code	Colours
# 070217	Natural
-	Black
-	Silver



JOINT 3.3

Code	Colours
# 070213	Natural
# 070203	Black
# 070903	Silver



ROUNDED 1.1

Code	Colours
# 070218	Natural
# 070209	Black
# 070908	Silver



JOINT 4.1

Code	Colours
# 070214	Natural
# 070204	Black
# 070904	Silver



ROUNDED 4.1

Code	Colours
# 070219	Natural
# 070210	Black
# 070909	Silver



JOINT 5.2

Code	Colours
# 070215	Natural
# 070205	Black
# 070905	Silver

= TUBES



PLAIN TUBE

25mm square cold-rolled mild steel tube. Stove-enamelled black.

Code	Colours
# 071121	Black



DOUBLE SLOTTED TUBE

Square tube, punched with 20mm x 3mm slots at 40mm centres, on two opposite faces of the tube. Stove enamelled black.

Code	Colours
# 071123	Black



SINGLE SLOTTED TUBE

Square tube, punched with 20mm x 3mm slots at 40mm centres on one face of the tube. Stove-enamelled black.

Code	Colours
# 071122	Black

All prices/specifications subject to change without notice.

ADD 10% GST AUSTRALIA ONLY

Replaces all previous versions

Effective 1st October 2007

SPEEDFRAME Innovative Modular Framing Systems

COMPONENTS

ACCESSORIES

INSERTS



*USE FOR FREQUENT
KNOCKDOWN &
ASSEMBLY

Moulded in hard, creep resistant plastic in black, grey and clear (Soft white polyethylene inserts are available for building less rigid structures which may be frequently knocked down and reassembled).

	Code	Colours
#	070301	Black
#	071011	Grey
#	070303	Clear
#	070302	White*

NYLON BLACK CAP



Loading: Up to 227kg each.

	Code	Colours
#	070401	BRIGHT ZINC

ADJUSTABLE FOOT



Plastic foot with zinc-plated cap. Adjustable for height and angle. Loading: Up to 227kg each.

	Code	Description
#	070402	2 PARTS

FLANGE



Bright zinc-plated steel, punched to accept countersunk screws. Flange used to secure adjustable foot to base.

	Code	Colours
#	070404	BRIGHT ZINC

PLUG FITTING CASTOR Ø50



These castors are not suitable for trolleys used over uneven floors or for heavy-duty use. 51mm diameter black acetal plastic wheel on silver-grey swivel mounting. Loading: Up to 30kg each. Supplied in packs of 4 (2 left-handed, 2 right-handed).

	Code	Description
#	070414	2 PARTS

PLUG FITTING CASTOR Ø102



Wheel fitted by means of a plug into the end of the tube. Grey rubber tyred wheel on zinc-chromate swivel mounting. Loading: Up to 39kg each, or 57kg each if used with Speedframe reinforced leg unit.

	Code	Description
#	070416	2 PARTS

REINFORCED LEG UNIT



Use in conjunction with 102mm diameter plug-fitting castors. The unit must be fixed to the horizontal frame tubes with drive screws passing through the plate and tubes and into the horizontal joint spigots.

	Code	Colours
#	070420	Black

ADJUSTABLE SHELF BRACKET CUP



Glass reinforced nylon. Perforated to accept shelf-fixing screws, or flat headed grommets for supporting glass shelving. Loading: Four brackets safely carry a distributed load of 120kg.

	Code	Colours
#	070426	Black

Replaces all previous versions

Effective 1st October 2007

SPEEDFRAME Innovative Modular Framing Systems

COMPONENTS

ACCESSORIES



SINGLE SHELF SUPPORT

Steel, stove-enamelled black.
 Perforated to accept plastic shelf spacer or shelf-fixing screws.
 Loading: Up to 45kg per support.

Code	Colours
# 070439	Black

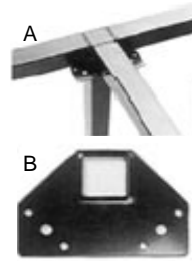

DOUBLE SHELF SUPPORT

Steel, stove-enamelled black.
 Perforated to accept plastic shelf spacer or shelf-fixing screws.
 Loading: Up to 45kg per support.

Code	Colours
# 070440	Black



REMOVABLE SHELF SUPPORT

Supports shelves up to 25 mm thick.
 Steel stove-enamelled black.
 Perforated to accept plastic shelf spacer or shelf-fixing screw.
 Loading: Up to 91 kg per support.

Code	Colours
# 070441	Black



PLASTIC SHELF SPACER

For building up shelves of less than 25 mm thickness to flush with top of face of tube. They clip onto single, double or removable shelf supports or onto one another. Polyethylene 3.2 mm thick in black. Perforated to accept shelf-fixing screw.

Code	Colours
# 070445	Black



PLASTIC CENTRE CLIP, END CLIPS WITH GROMMETS

These clips locate onto shelf brackets and with grommets fitted, provide a cushioned support for glass shelves. Finish: Clear plastic.

Code	Colours
# 071581	END CLIP
# 071582	CENTRE CLIP
# 071583	GROMMET



ANCLOR PLATE

Die-cast in aluminium alloy and stove-enamelled black.

Code	Colours
# 070452	Black



SINGLE SLOT STRIPPING

A "C" Shaped channel (19mm x 13mm) with 20mm x 3mm Double fin opposite (# 070835) slots in the face at 40mm centres and fixing holes at 202mm centres.



SINGLE SLOT STRIPPING

A "C" shaped channel (32mm x 13mm) with two parallel rows of 20mm x 3mm slots in the face at 40mm centres and fixing holes at 202mm centres.

Length	Code	Colours
1500 mm Length	# 071201	White
	# 071203	Chrome
		Raw
1800 mm Length	# 071211	White
	# 071213	Chrome
		Raw
2100 mm Length	# 071221	White
	# 071223	Chrome
		Raw
2400 mm Length	# 071231	White
	# 071233	Chrome

Length	Code	Colours
1500 mm Length	-	White
	-	Chrome
	-	Raw
1800 mm Length	# 071311	White
	# 071313	Chrome
		Raw
2100 mm Length	# 071321	White
	# 071323	Chrome
		Raw
2400 mm Length	# 071331	White
	# 071333	Chrome

Replaces all previous versions

Effective 1st October 2007

SPEEDFRAME Innovative Modular Framing Systems

	Raw
--	-----

	Raw
--	-----

All prices/specifications subject to change without notice.

ADD 10% GST AUSTRALIA ONLY

COMPONENTS

ACCESSORIES



SHELF BRACKETS - STRAIGHT

Steel stove-enamelled bracket.
 Lengths: 150mm to 500mm from face of tube
 Loading: Up to 45kg per bracket depending on the design of the framework.

Length	Code	Colours
150 mm Length	# 071501	White
	# 071502	Chrome
		Raw
200 mm Length	# 071511	White
	# 071512	Chrome
		Raw
250 mm Length	# 071521	White
	# 071522	Chrome
		Raw
300 mm Length	# 071531	White
	# 071532	Chrome
		Raw
350 mm Length	# 071541	White
	# 071542	Chrome
		Raw
400 mm Length	# 071551	White
	# 071552	Chrome
		Raw
450 mm Length	# 071561	White
	# 071562	Chrome
		Raw
500 mm Length	# 071571	White
	# 071572	Chrome
		Raw

TUBE PROFILES - LENGTH 3660mm

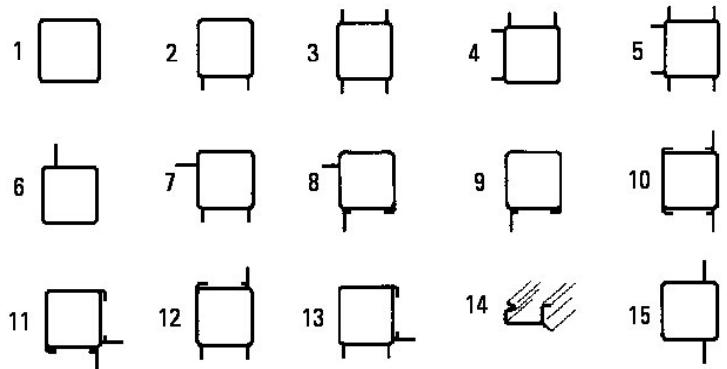

Descriptions	Code	Picture
Plain Alloy tube	# 070821	Pic. 1
1-way cladding tube	# 070822	Pic. 2
2-way cladding opposite	# 070823	Pic. 3
2-way cladding adjacent	# 070824	Pic. 4
3-way cladding tube	# 070825	Pic. 5
Fin tube	# 070826	Pic. 6
Fin cladding tube	# 070827	Pic. 7
Fin glazing tube	# 070828	Pic. 8
Single glazing tube	# 070829	Pic. 9
2-way glazing opposite	# 070830	Pic. 10
2-way glazing adjacent	# 070831	Pic. 11
Glazing cladding opposite	# 070832	Pic. 12
Glazing cladding adjacent	# 070833	Pic. 13
Glazing bead alloy	# 070834	Pic. 14
Double fin opposite	# 070835	Pic. 15

TOOLS & DRIVE SCREW



TEMPLATE

Template for mitering fins on alloy tube and glazing bead.

Code	Colours
# 071001	-



DRIVE SCREW

Metal screw for pinning joints and tube together where vibration or pullout is likely, 19mm long. Driven in with hammer.

Code	Colours



CLIPPERS

For mitering fins on alloy tube (use with template)

Code	Colours
# 071002	-



SOFT FACE HAMMER

Code	Colours
# 071003	-



CUTTING BLOCK

Code	Colours
# 071006	-

Replaces all previous versions

Effective 1st October 2007

SPEEDFRAME Innovative Modular Framing Systems

070450 ZINC PLATED

All prices/specifications subject to change without notice.

ADD 10% GST AUSTRALIA ONLY

OTHER APPLICATIONS

Commercial



Internet Centre, Sydney CBD, Australia

Due to Speedframe's patented design, on-site assembly can be done quickly and easily. Pre-finished tubes and accessories have end-caps to ensure a neat finish, while only simple tools are used to assemble the system.



Resort, Mid North Coast NSW, Australia

The Speedframe system installed a stunning reception area and kiosk that exceeded the expectations of the clients. The simple system gave the architects scope to use traditional materials and different surface finishes.

Industrial



1



2



3



1. Custom made Benches
2. Displayer Units
3. Trolleys
4. Worktables & benches
5. Industrial Work Table

Operates on a strong, die-cast connector system which can be taken apart and reassembled in a different configuration if required. Great benefit to business that need to add more workspace facilities while they are undergoing expansion.

Replaces all previous versions

Effective 1st October 2007

SPEEDFRAME Innovative Modular Framing Systems

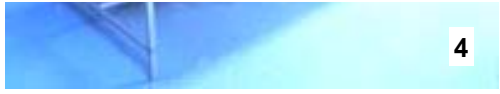

very quick and easy installation.
 The complete system is as strong and sturdy as any welded alternative.

OTHER APPLICATIONS

Retail



1. Soul Vision Eureka Towers
2. Display stands Soul Pattison Pharmacy

Aluminium die-cast connectors to provide not only a strong connection, they also allow for different powder coating options.

Pre-finished tubes and accessories have end-caps to ensure a neat finish. Should they be required, castors can be installed for movement or screw-in feet can be fitted to level or lift items from the floor.

Lifestyle / Office



1. Free standing storage unit
2. Reception
3. Corner workstation
4. Filing and storage unit

Unique & incredible versatility!
 You can complete an entire office fitout including workstations, acoustic screens, credenza units, document files and trolleys, boardroom tables and much more with the same system!

The beauty is in the uniformity.
 A minimalist theme that is subtly smart can be achieved with great success.

Domestic / Restaurant



Replaces all previous versions

Effective 1st October 2007

SPEEDFRAME Innovative Modular Framing Systems

Stunning contemporary look you can achieve.
Developers, architects, designers, restaurant owners and home owners have worked with us to generate some truly innovative designs

